

MITSUBISHI ELECTRIC INDUSTRIAL ROBOT MELFA Smart Plus



MELFA Smart Plus

Supported robots: FR series CR series

MELFA

Smart Plus

MELFA Smart Plus is an option that brings next-generation intelligence to MELFA FR series robots.

Inserting a MELFA Smart Plus card into a robot controller enables a multitude of intelligent functions.



Intelligent function



AI function

Predictive maintenance function



P03

Failing drive parts are detected before abnormalities in robot behavior become apparent. Downtime of production equipment is reduced.

Preventive maintenance function



P04

Tracking the robot's operating status helps manage the condition of the robot. Maintenance is now even more efficient.

- a. Maintenance simulation
- b. Wear calculation function

Enhancement function for force sense control



P05

Parameters for the optimum operation pattern are found using repeat learning in a short amount of time. Set-up and tact times are reduced.

MELFA-3D Vision enhancement function



P07

Reduced startup time thanks to automatic parameter adjustments which utilize our proprietary AI technology "Maisart".

2D vision sensor enhancement function



P09

Various vision applications are used to facilitate vision alignment.

Supported robots: FR series **NEW** CR series



Calibration assistance function

P11

Easy set-up of 2D vision sensors and improved job precision.

- a. Automatic calibration
- b. Work coordinate calibration
- c. Relative position calibration

Coordinated control of additional axis

P15

Using a robot with an RTU enables manufacturing and assembly at user specified speeds.

RTU : Robot Transport Units

Robot mechanism thermal compensation function

P16

Compensates for thermal expansion of the robot arm to increase position accuracy.



A brand encompassing Mitsubishi Electric's proprietary AI technology, including "compact AI" and AI basic and applied technologies.

Name	Model	Usable functions
MELFA Smart Plus card	2F-DQ511	One of the A-type functions can be activated.
	2F-DQ521	One of the B-type functions can be activated.
MELFA Smart Plus card pack	2F-DQ510	All the A-type functions can be activated.
	2F-DQ520	All the A-type and B-type functions can be activated.

Predictive maintenance function



QUESTION

I do not want the production line to stop when parts break. Can I get information on failing parts in advance?



The predictive maintenance function lets you know of failing or deteriorating parts at an early stage. This reduces downtime!



Fault detection function

The fault detection function detects failing or deteriorating robot parts at an early stage. Detecting failing parts before abnormalities in robot behavior become apparent reduces downtime.

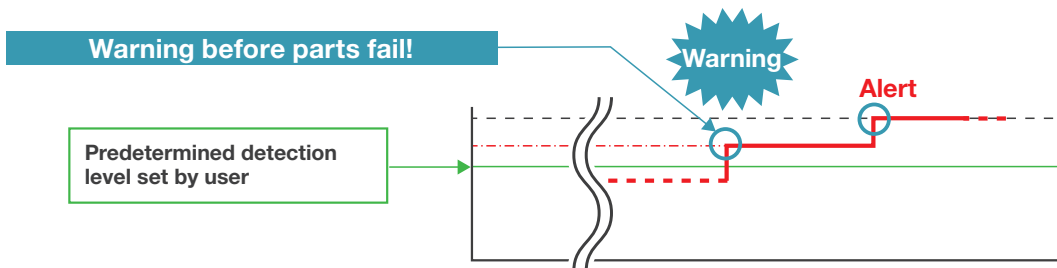

Set a threshold value that suits your needs. A warning of failing or deteriorating parts will trigger if the value exceeds the predetermined detection level.

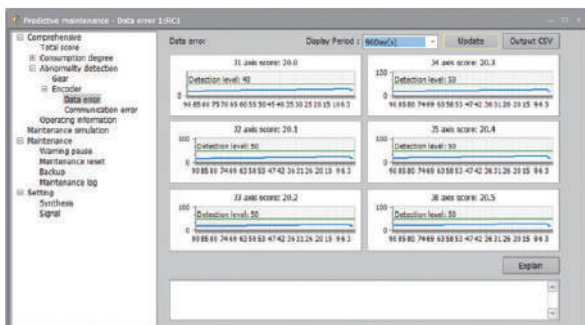

It is possible to read scores (values) of a reduction gear and an encoder (data error and communication error)

It is possible to read log data of the past 365 days



- Applicable parts: Reduction gears, encoders, batteries
- Robot models predictive maintenance is available for:

Vertically articulated robots	Horizontally articulated robots
RV-2FR(L), RV-4FR(L), RV-7FR(L/LL) RV-13FR(L), RV-20FR, RV-8CRL	RH-3FRH, RH-6FRH, RH-12FRH, RH-20FRH, RH-3FRHR, RH-3CRH, RH-6CRH

*1: The score is calculated for reduction gears while the motor is running at a speed of 500 rpm or more.
 *2: Some joints do not support the fault detection function. Details can be found from Page 17 onwards.

Our proprietary AI technology extracts a characteristic waveform at high speed, based on accumulated machine data.

- Note
- This function is only supported by the FR series with robot controller CR800-D/R/Q software Ver. A4 or later.
 - This function is supported by the RH-3CRH, RH-6CRH, and RV-8CRL with robot controller CR800-D software Ver. A5p or later.
 - Supported with RT ToolBox3 Ver.1.50C or later
 - The preventive maintenance function (A-type function) is also available if the predictive maintenance function (B-type function) is activated.

Preventive maintenance function



QUESTION

I don't know which parts to repair or replace.
Can I get this information in advance?

The preventive maintenance function lets you know beforehand when parts should be maintained or replaced. Maintenance is now even more efficient!

Maintenance simulation

The preventive maintenance function estimates the recommended maintenance period and when to replace consumable parts. This is done by observing repeat patterns in sample programs used by the robot or executed in the simulator in RT Toolbox3.*1

- Output data: Grease replenishment period (per axis) / Timing belt replacement period (per axis) / Recommended maintenance period for overhaulable parts (per axis)*2
- *1: This function is supported by the RH-3CRH, RH-6CRH, and RV-8CRL with RT Toolbox3 Ver.1.90U or later.
- *2: For overhaulable parts such as reduction gears, bearings, ball screws, the internals of ball splines, the part which needs to be overhauled the earliest will be displayed.

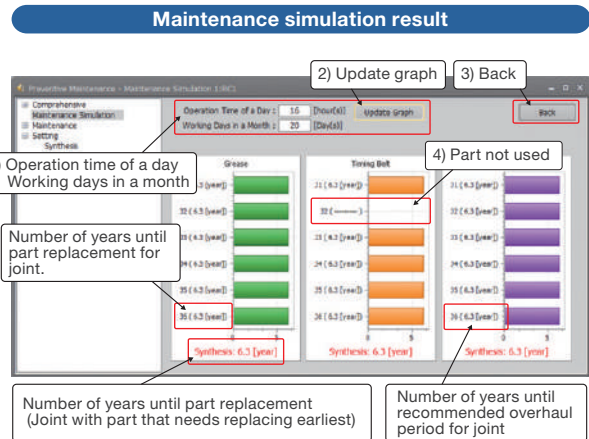

Wear calculation function

A function that calculates the wear of components*3 from the operational status (current, load, etc.) based on the robot's movements and posture. It also calculates the time left until inspection, maintenance and overhaul periods.

- *3: The wear ratio of each part is a reference value to assist the maintenance and inspection schedule calculated based on the robot's operational status. It does not guarantee that this is the actual remaining life of the part.
- *4: Download sample GOT screen data from the Mitsubishi Electric FA Global Website.

- Applicable parts: Consumable parts (grease, timing belts, etc.), overhaulable parts (reduction gears, bearings, ball screws, ball splines)

— Current maintenance prediction window —
Grease replenishment and belt replacement times can be checked in this window.

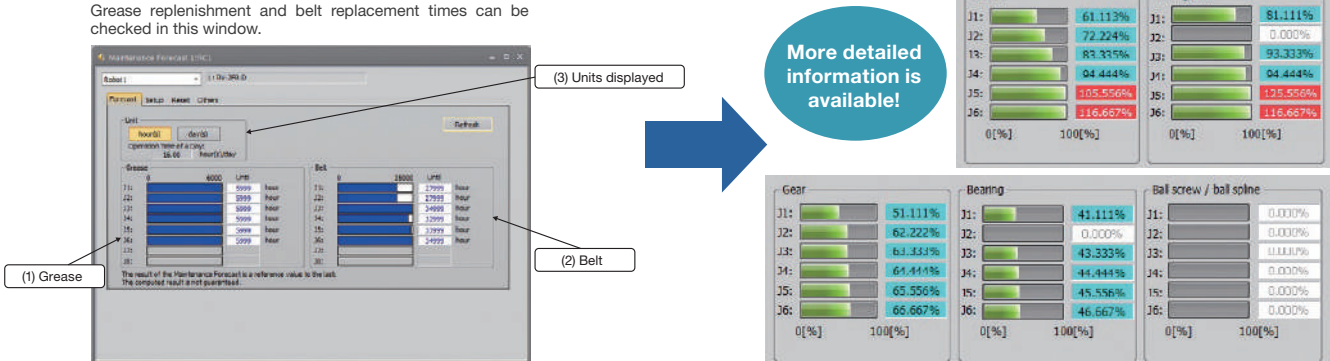

- Note
- This function is only supported by the FR series with robot controller CR800-D/R/Q software Ver. A3 or later.
 - This function is supported by the RH-3CRH, RH-6CRH, and RV-8CRL with robot controller CR800-D software Ver. A5p or later.*5
 - Only supported with robot controller CR800-D/R/Q software Ver.A3 or later.
 - Supported with RT ToolBox3 Ver.1.30G or later / Simulation is not supported when using RT ToolBox3 mini.

*5: When using this function after the software has been updated from an unsupported version, the calculated wear ratio will not be correct as the wear ratio will not have been calculated during the time that the unsupported software version was used.

Enhancement function for force sense control

QUESTION

Is there an easier way to adjust force sensor parameters?



AI adjusts parameters to give the optimum operation pattern. Anyone can adjust parameters quickly and easily!



Enhancement function for force sense control

AI adjusts parameters automatically for optimum force sense control. Parameters can be adjusted by anyone easily in a short amount of time as AI selects the most suitable parameter for you. Set-up and tact times are reduced by 60%! (*1)

*1: Compared to the time taken for connector insertion with our settings.

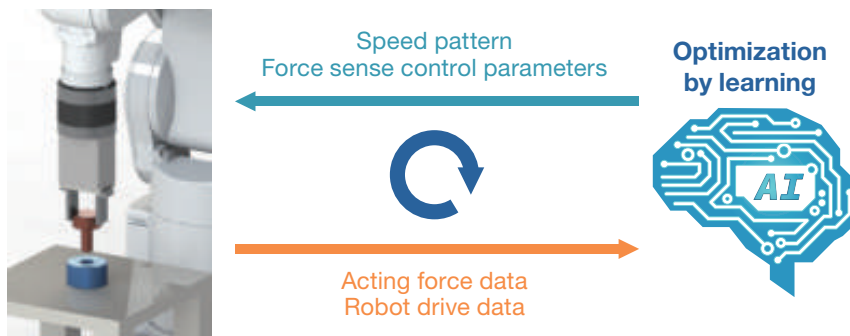

Our proprietary AI technology adjusts the parameters for the optimum operation pattern. This is achieved by utilizing the data obtained from learning, which is carried out in a short amount of time.

Force sensor



A force sensor has the "force sense function" which provides a sense of force to a robot. The robot can sense force applied to its hand during the assembly or machining of workpieces just like a person, enabling work which requires fine force adjustment and force detection.

Main features

- Controls the robot so that it moves delicately along the contours of a workpiece.
- Operates with a constant force in a direction specified by the user.
- Changes the delicacy level for the robot movement and the conditions of contact detection during operation.
- Obtains the position and force data at the time of contact.

Setting method

Step1

Selecting an operation type

- (1) Select [Create force movement] from the project tree.
- (2) Select the type force sense movement to be used for the program.

Force sense movement

a. Insertion and fitting

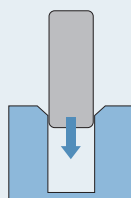

b. Phase match insertion



c. Contact detection

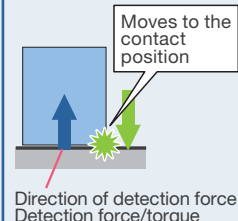

Step2

Operation settings

Set the operation settings of the force sense operation you want to create.

- (1) Teach the start position and the end position.
- (2) Set conditions to determine the operation has finished.
- (3) Set limits for the speed and force (The robot will operate in such a way that these values will not be exceeded while learning).

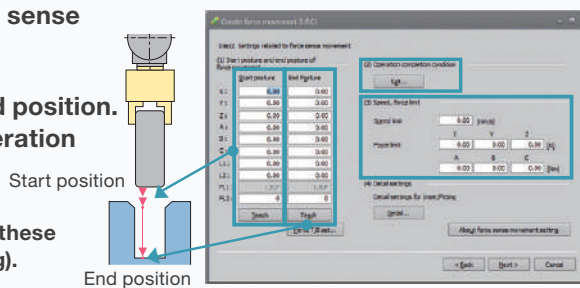

Step3

Settings for learning

Configure the learning settings

(e.g. permissible acting force/number of times the robot repeats force movement).

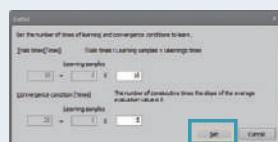
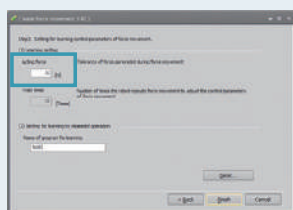

Push the "Complete" button to create a learning program automatically



Step4

Learning

Repeat the operation by executing the created learning program.

By repeating the learning operation,

AI optimizes control parameters, positions and speed!

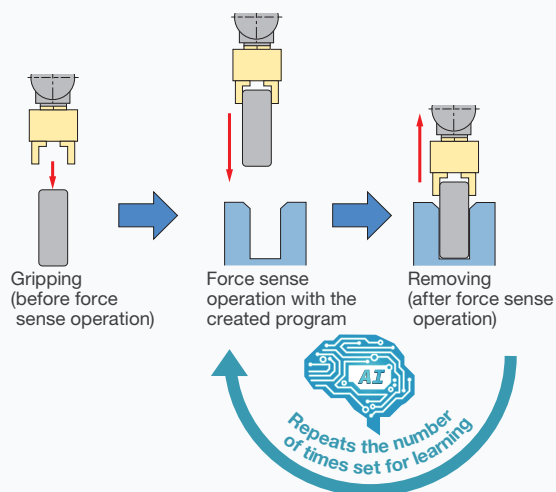

Note

- Only supported with robot controller CR800-D/R/Q software Ver.A4 or later
- Supported with RT ToolBox3 Ver.1.50C or later

MELFA-3D Vision enhancement function

QUESTION

Is it hard to set up a 3D vision sensor for bin picking ?



AI automatically adjusts 3D vision sensor parameters. Set-up is simple!



Automatic parameter setting with AI

(Only when model-less recognition is used)

Sensor parameter adjustment which requires a high level of specialist knowledge is automated with our proprietary AI technology. Anyone can adjust parameters quickly and easily just like a pro!

Adjustment time: Reduced from **8 hr** → **1 hr**!*

- *1: Time varies depending on edge computing/control unit capability, workpiece 3D CAD data and the settings of learning conditions.
- *2: This optional function is supported with the options MELFA-3D Vision 2.0 and 3.0.
- *3: The only models that support MELFA Smart Plus are the N35-804-16-IR, N35-806-16-IR, and N35-808-16-IR.



MELFA-3D Vision 3.0



Camera head supplied by customer
Manufacturer: ENSENSO GmbH.
(Supplier: IDS Imaging Development Systems GmbH.)

Set-up procedure

Step1

Import model of workpiece

Import a 3D model of the workpiece.

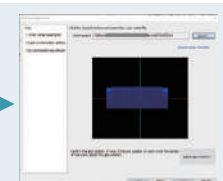



Step2

Set learning conditions

Set the bin size and conditions required for learning.

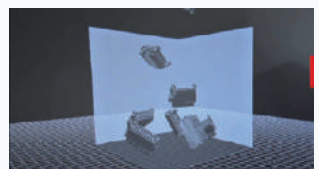
(1) Adjust the grasp position of the model workpiece.
(2) Configure the learning conditions parameter.

Step3

Automatic adjustment

Adjustment of recognition parameter.

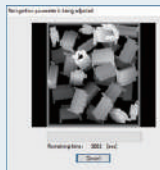

← Recognition parameter being adjusted



← Randomly stacked parts are replicated in a simulation. The most suitable parameter is selected and adjusted.

Step4

Parameter optimization

Adjust sensor parameters



← Adjustment of the environment adaption parameter

Note Model-less recognition does not usually require a 3D model. However, a 3D model of the workpiece is required for this function.

■ What is MELFA-3D Vision 3.0?



MELFA-3D Vision 3.0



Camera head supplied by customer
 Manufacturer: ENSENSO GmbH.
 (Supplier: IDS Imaging Development
 Systems GmbH.)

MELFA-3D Vision 3.0 is software that connects a compact 3D vision sensor for robots to measure and recognize parts. It uses a camera head that can measure distances, which allows it to take the dimensions of randomly stacked parts and recognize them.

Main features

- The camera head is available for both hand eyes and fixed cameras.
- Supports model-less recognition and model matching recognition.

Model-less recognition? Model matching recognition?

Model-less recognition

Model-less recognition is a method used to pick up the workpiece by finding a place on the workpiece where the hand tool can grasp or apply suction to. This means that there is no need to register a workpiece.

■ Main hand types that can be used

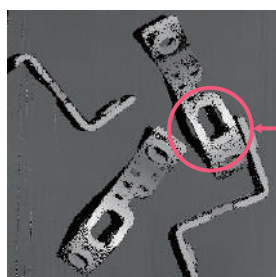

Imaging (measuring)

Parts closest to the camera displayed in white

Search for grasp/suction point

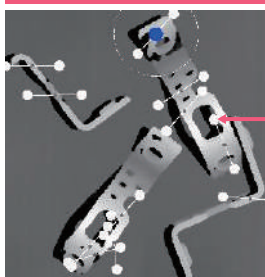

Round features detected for hand location (for pincer hand)

Model matching recognition

Model matching recognition is a method of picking up the workpiece by finding a workpiece that matches the registered 3D CAD model. This means that the grasp position and orientation of the workpiece can be specified.

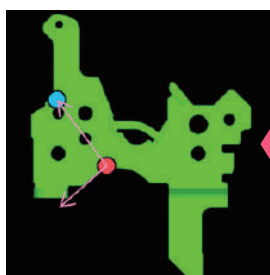

▲ Registered 3D CAD model

Matching

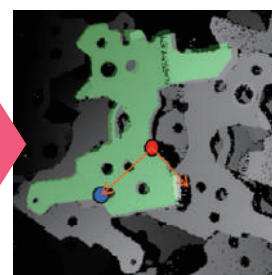

▲ Imaging

2D vision sensor enhancement function

NEW

QUESTION

Is it possible to use a 2D vision sensor more casually?



Robot systems can be set up easily using the vision sensor without specialist knowledge!



Various vision applications enabling "easy" set-up by "anyone"

The steps from easy set-up to creation of a robot program can be performed by intuitive screen operations.

Calibration and application program are automatically created, enabling immediate operation checks.

Application examples

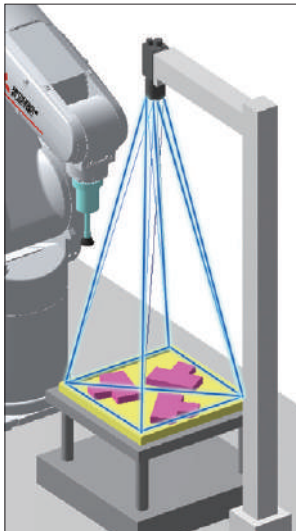

Fixed camera used for picking

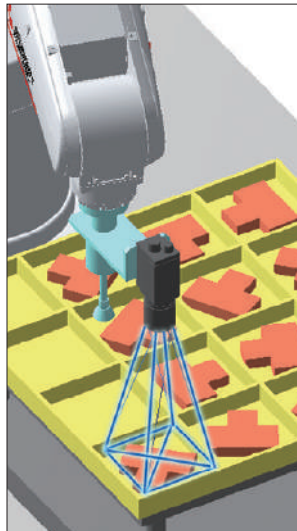

Hand camera used for picking

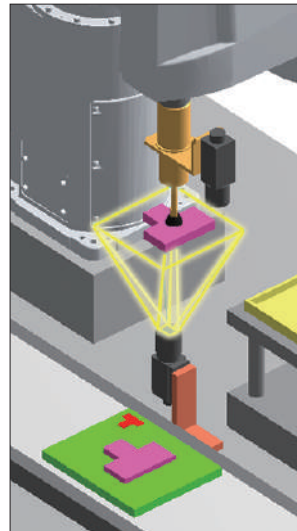

Multiple cameras used to grip/placement correction

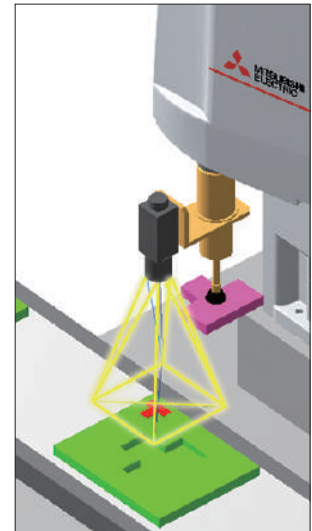

Application example video

A vision application can be set up easily by following the instructions on the setting screens even when robot programs that require specialist knowledge have not been created!



Compatible device

Vision sensor	Mitsubishi Electric : MELSENSOR VS70/VS80 series Cognex : In-Sight 7000/8000
Hand ^{*1}	Only a single hand compatible with ON/OFF control of the robot hand dedicated output signal or general-purpose output signal is available. For pneumatic hands, both single solenoid type and double solenoid type are available.

※1 : The multifunctional electric gripper option is not available.

Steps from settings to program creation can be performed easily by following the steps on the screens!

Step1 Selecting an application and camera

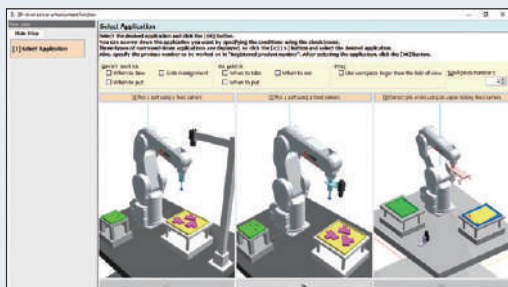

Select application (9 types)

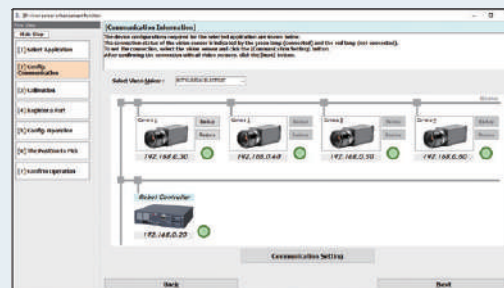

Select camera (4 units max.)

Step2 Performing calibration and registering a workpiece

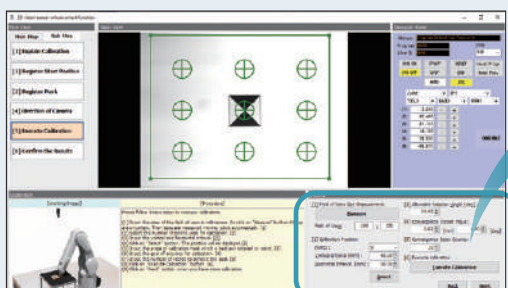

Calibration

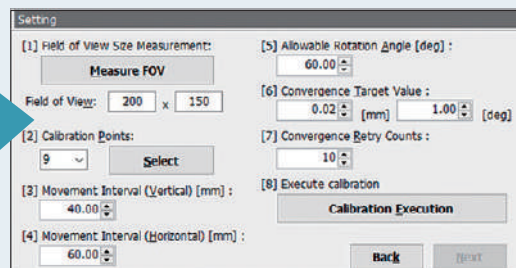

Wizard window

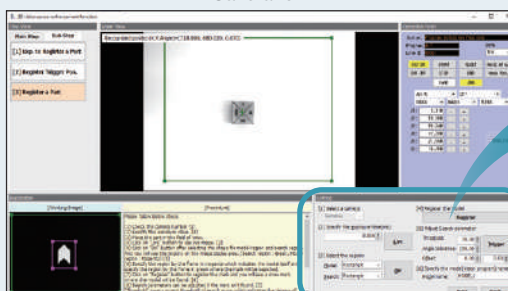

Workpiece registration window

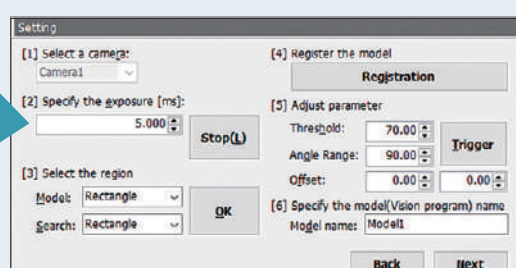

Wizard window

Step3 Setting operation and grasp position

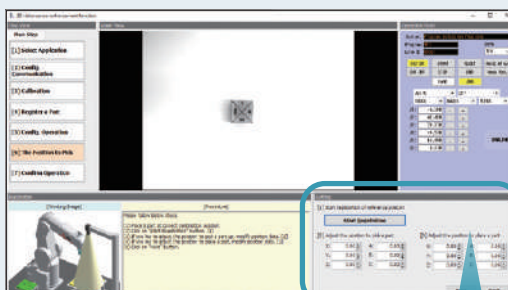

Registering a workpiece recognition point, grasp position, and the position above the workpiece

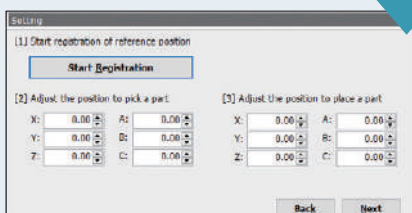

Wizard window

Step4 Checking operation and saving the program

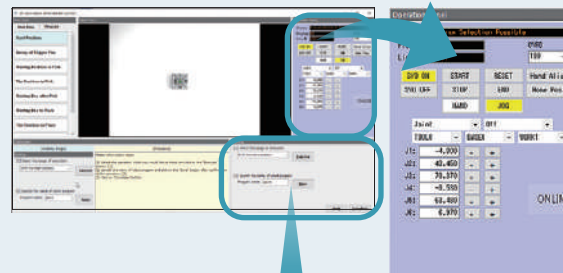

Checking the operation to the registered position

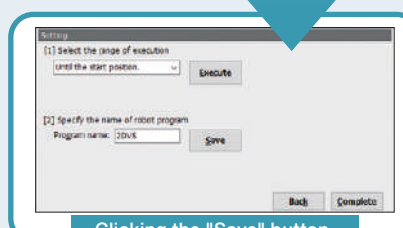

Clicking the "Save" button to create a program

Calibration assistance function



QUESTION

Is teaching a 2D vision sensor hard work?
How accurate are they?



Time-consuming teaching has been automated and accuracy improved!



Automatic calibration

Robot/2D vision sensor integration

Input multiple values such as the robot and sensor coordinates, and the relative position between the robot and camera is automatically calculated.



Calibration of work coordinates

Robots and peripheral devices/jigs

Calibration between the robot coordinates and optional coordinates such as peripheral devices, jigs, and workpieces is performed using a vision sensor.



Relative position calibration

Robots working with robots

Multiple robots recognize the same workpiece coordinates and use them to find the relative position between each other.



System architecture

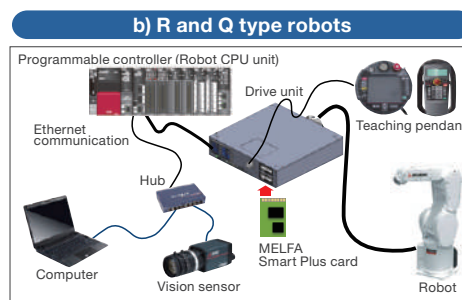
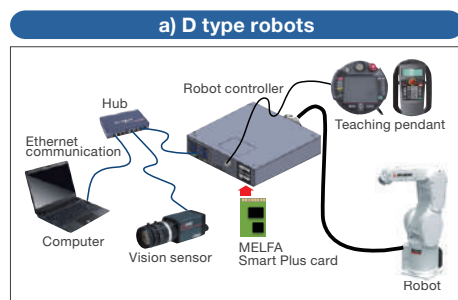

Vision sensor **MELSENSOR**

VS80 The VS80 utilizes PatMaxRedLine^{®1} to rapidly identify workpieces. Its compact size means it can be set up in confined, hard-to-reach places or attached to a robot hand. It is a wire saving, stand-alone vision sensor featuring PoE. ¹ High-speed, high-precision pattern matching algorithm.

VS70 The VS70 utilizes PatMaxRedLine[®] to rapidly identify workpieces. An abundance of options such as lighting, lenses, and filters can be chosen to customize it to the customer's needs.

Automatic calibration



QUESTION

I want to use 2D vision sensors.
Are they difficult to set up ?

Calibration of coordinates can be done automatically.
Set-up is extremely simple!

Simple set-up!

Automating the teaching process has made set-up easier!

Automatically moves to multiple points and calculates the camera angle and scale

↓

Checks markers while automatically changing multiple points and angles.
Calculates marker tool length

↓

Moves to automatically taught position
Carries out calibration between the robot and camera

Camera position

Camera's FOV

Vision sensor resolution

Generation of robot program

Teaching done automatically (manual adjustment possible)

Configure settings such as the camera position, FOV, and resolution in the automatic calibration window. Automatic teaching and automatic calibration is possible.

Improved accuracy!

With automatic calibration, operating conditions are stabilized and accuracy is increased.

Old method (manual)	Set-up time (m)	20	➔	Automatic calibration	Set-up time (m)	1
	Accuracy (mm)	±0.2			Accuracy (mm)	±0.05

Cameras can be mounted in three positions

Fixed above workpiece (downward-facing)

For checking the location of objects

Fixed below workpiece (upward-facing)

For adjusting the position of grasped workpieces

Hand eye

For checking the position of a workpiece

Calibration of work coordinates



QUESTION

Is calibration required every time the relative position of the workpiece and robot changes?



Teaching is now automated. This makes calibration of the robot and peripheral devices extremely simple.



Troublesome teaching work eliminated!

Teaching of workpiece coordinates is automated. Set-up time and troublesome work reduced!

Use the automatic calibration function to carry out calibration between the robot and hand eye in advance.

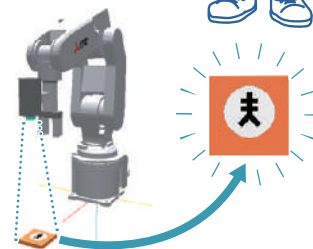

Step1

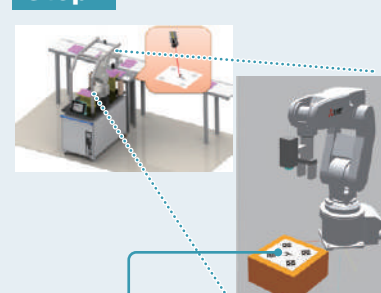

Calibrate the hand eye with the markers (calibration sheet) on the platform and adjust the coordinates for the platform on the opposite side.

Step2

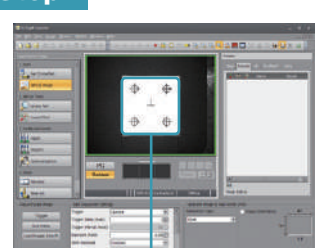

Move the hand eye so that the markers are in the center of its FOV. Detect the pre-registered origin point and crosshairs then adjust the position of the jig.

Step3

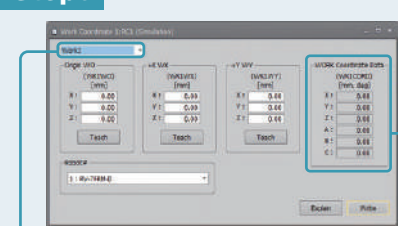

1) Switch to the specified workpiece coordinate number.
2) Check that the values of the workpiece coordinates have changed.

The workpiece coordinates parameter window will appear. Check that the workpiece coordinate data of the specified workpiece coordinate number has changed.

Calibration possible even in environments where workpiece coordinates and the robot's relative position change!

Automatic calibration is possible even in environments where the workpiece coordinates and the robot's relative position change. Easy calibration of robots and pallets installed on automated guided vehicles (AGVs) or carts.

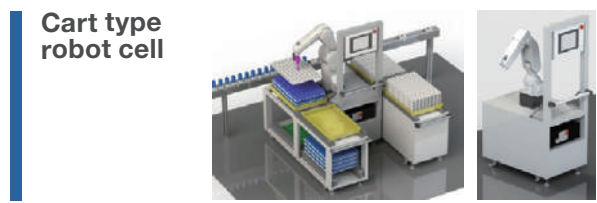

Note • This function can only be used when a 2D vision sensor is used as a hand eye.
• Horizontal multi-joint robots (4-axis) not supported.

Relative position calibration



QUESTION

I want to use interference avoidance and collaborative operation functions. Isn't it difficult to teach the robot these?



Intricate teaching of the robot is automated. Setting up interference avoidance and collaborative operation is now extremely simple!



Reduce man-hours spent improving accuracy and setting up interference avoidance and collaborative operation!

Calibration is automated so that the same work coordinates can be used by multiple robots. Reduce worker errors and workloads!

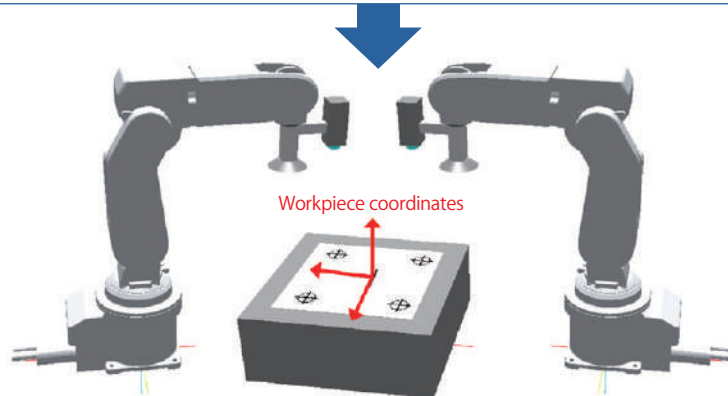

Example

Two robots used instead of a jig

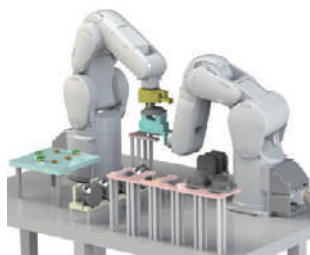

Collaborative operation allows for the transportation of flexible materials

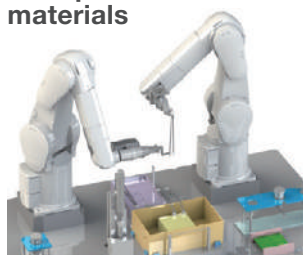

Interference avoidance in areas of limited space

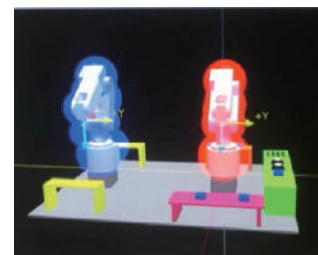

Note

- MELFA FR series D type robots not supported.
- Horizontal multi-joint robots (4-axis) not supported.

Coordinated control of additional axis



QUESTION

Can robots work on large workpieces that exceed their operating range?

Robots can now work on large workpieces that exceed their operating range.

Workpieces can be assembled precisely and inspected while they are moving!

Coordinated operation between the robot and an additional axis makes it possible for the robot to work on workpieces that exceed its operating range. Constant speed control (spline interpolation) of the workpiece and continuous operation is now possible.

Compatible servo system

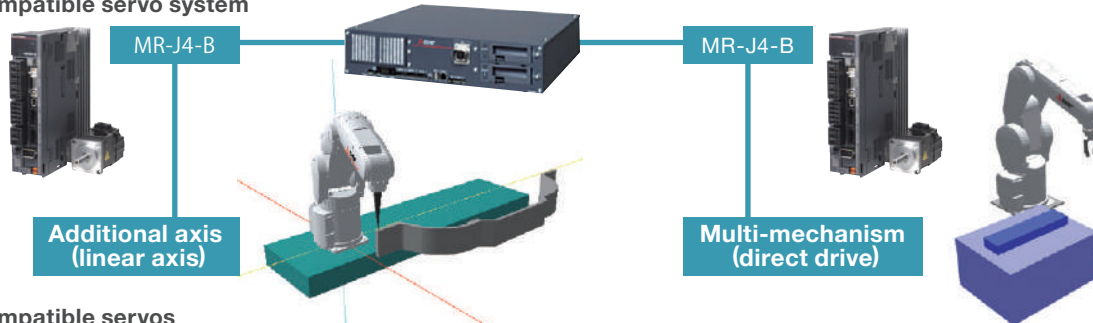

Compatible servos

Manufacturer	Servo amplifier	Model
Mitsubishi Electric Corporation	MELSERVO-J4 series	MR-J4-□B (ABS specification) MR-J4W□-□B (ABS specification)

Example

Sealing and machine work on large-scale workpieces

Using a robot with an RTU allows the robot to work uninterrupted on large-scale workpieces that exceed its operating range.

Linear, circular, and spline interpolation supported.

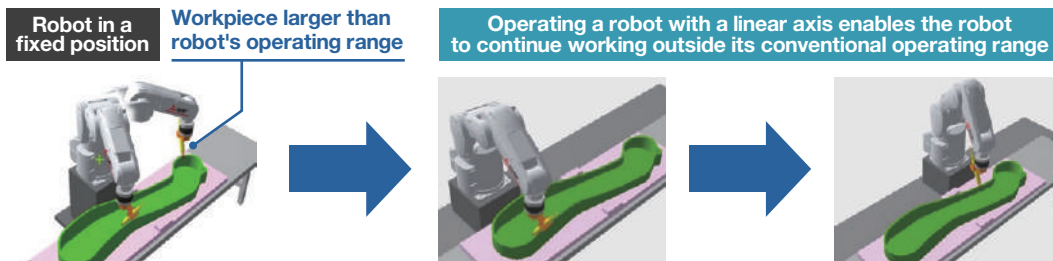

QUESTION

What can be done about thermal expansion of the robot arm?

Thermal expansion of the robot arm can be compensated for with the thermal compensation function!

Improved accuracy!

The thermal compensation function compensates for thermal expansion of the robot arm to increase positioning accuracy. This improves system stability and the quality of products. The total cost of systems can also be reduced as no external sensor is required for temperature compensation.

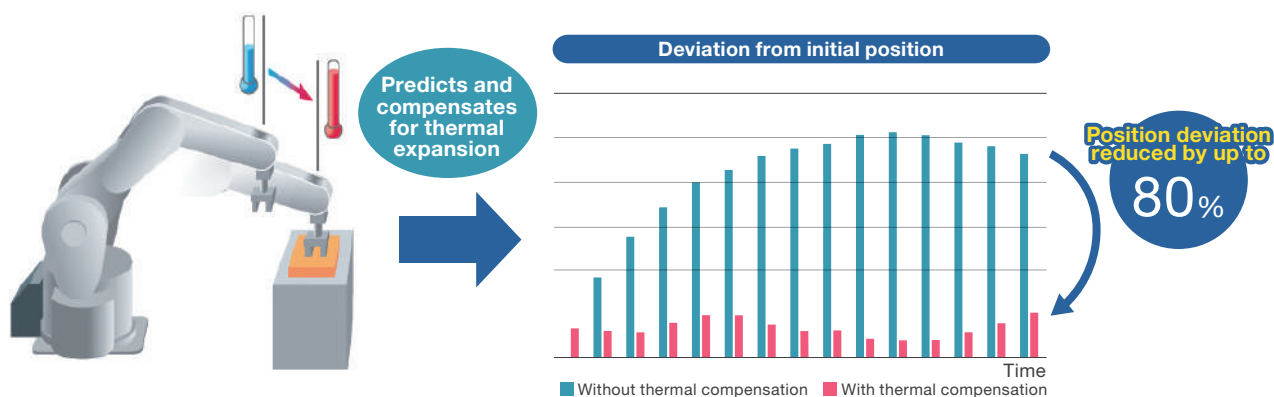

* Compensation accuracy varies depending on the robot model and operating conditions (load, position, speed, etc.).

Example

Useful for high-precision tasks such as the assembly and arrangement of minute parts

(Installing ICs on circuit boards and transporting unusually shaped objects)

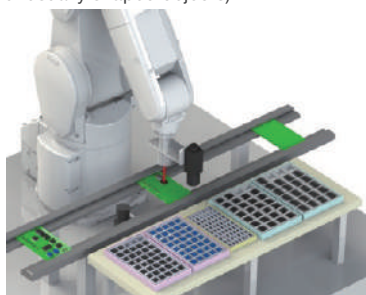

Maintained accuracy for work that involves high temperatures due to high-speed operation

(In-transport arrangement of minute parts)

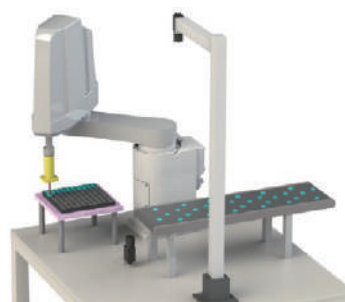

Note

- This function is supported by the RH-3CRH, RH-6CRH, and RV-8CRL with robot controller CR800-D software Ver. A5p or later.
- Enable this function at startup. If this function is enabled while the robot is being taught, or disable after the teaching process, the robot may deviate from its taught position during operation.

Functions reference

Outline of features

Classification	Name	Type	Description	
Intelligent function	2D vision sensor enhancement function	A	Supports 2D vision alignment using a vision application. * Only supported with robot controller software Ver.C2b or later and RT ToolBox3 Ver.1.91V or later.	
	Calibration assistance function	A	Calibrates the positions of the robot and peripheral devices using a 2D vision sensor. * Only supported with robot controller software Ver.A3 or later (MELFA Smart Plus card pack [2F-DQ510] Ver.A1 or later) and RT ToolBox3 Ver.1.00 or later.	
			Automatic calibration function	Automatically adjusts the coordinates of the vision sensor to increase position accuracy.
			Calibration of work coordinates	Adjusts the robot and workpiece coordinates using a vision sensor to increase position accuracy.
			Relative position calibration function	Calibrates the positions of multiple robots using a vision sensor. Increases position accuracy in collaborative operation.
	Robot mechanism thermal compensation function	A	Compensates for thermal expansion of the robot arm to increase position accuracy. * FR series: Only supported with robot controller software Ver.A3 or later (MELFA Smart Plus card pack [2F-DQ510] Ver.A1 or later) and RT ToolBox3 Ver.1.00 or later. * CR series: Only supported with robot controller software Ver.A5p or later and RT ToolBox3 Ver.1.90U or later.	
Coordinated control of additional axis	A	Performs highly accurate coordination (interpolation) with the additional axis (direct drive). * Only supported with robot controller software Ver.A3 or later (MELFA Smart Plus card pack [2F-DQ510] Ver.A1 or later) and RT ToolBox3 Ver.1.00 or later.		
AI function	Preventive maintenance function (Maintenance simulation and wear calculation function)	A	Tracks the robot's operating status to manage the condition of the robot. * FR series: Only supported with robot controller software Ver.A3 or later and RT ToolBox3 Ver.1.30G or later. * CR series: Only supported with robot controller software Ver.A5p or later and RT ToolBox3 Ver.1.90U or later.	
	MELFA-3D Vision enhancement function	B	AI technology helps adjust 3D vision sensor parameters automatically and improve the accuracy of part measurement and recognition. * Only supported with robot controller software Ver.A3 or later and RT ToolBox3 Ver.1.82L or later.	
	Predictive maintenance function (fault detection function)	B	Detects failing drive parts before abnormalities in robot behavior become apparent. * FR series: Only supported with robot controller software Ver.A4 or later and RT ToolBox3 Ver.1.50C or later. * CR series: Only supported with robot controller software Ver.A5p or later and RT ToolBox3 Ver.1.90U or later.	
	Enhancement function for force sense control	B	AI technology helps find optimum insertion patterns by repeated learning in a short amount of time. * Only supported with robot controller software Ver.A4 or later and RT ToolBox3 Ver.1.50C or later.	

Standard specifications Maintenance simulation

Output data	
Grease replenishment period	(Per axis)
Timing belt replacement period	(Per axis)
Recommended maintenance period for overhaulable parts (The part which needs to be overhauled the earliest is chosen from reduction gears, bearings, ball screws, and ball splines.)	(Per axis)

Wear calculation function

	Applicable part	Output data
Consumable part	Grease Timing belt	Grease consumption ratio (%) (Per axis)
		Timing belt wear ratio (%) (Per axis)
		Total score (consumption/wear ratio [%] and time to maintenance [h])* ¹
Overhaulable part	Reduction gear Bearing Ball screw/ball spline	Reduction gear wear ratio (%) (Per axis)
		Bearing wear ratio (%) (Per axis)
		Ball screw/ball spline wear ratio (%) (Per axis)
		Total score (wear ratio [%])* ²
Operation data	-	Servo ON time (h), operation time (h), actual operation time (h), power ON time (h), Servo ON count (times), and cumulative motor rotation count (rotations) (Per axis)

*1: Indicates the consumption or wear ratio (%) and the time to maintenance (h) of the part which needs to be maintained the earliest among consumable parts (grease and timing belts).

*2: Indicates the wear ratio (%) of the part which needs to be overhauled the earliest among overhaulable parts (reduction gears, bearings, ball screws, and ball splines).

Fault detection

Applicable part		Output data	
Reduction gear		Score	(Per axis) *Calculated when operating at 500 rpm or more
Encoder	Data fault	Score	(Per axis)
	Communication fault	Score	(Per axis)
Battery		Battery voltage	(Mechanism)

■ Axes used in the maintenance simulation/monitored by the wear calculation function

(Standard robots only)

(●: Used/monitored, —: Not used/monitored)

RV-2FR / RV-2FRL

Joint axis		J1 axis	J2 axis	J3 axis	J4 axis	J5 axis	J6 axis
Consumable part	Grease	●	●	●	●	●	●
	Timing belt	●	●	●	●	●	●
Overhaulable part	Reduction gear	●	●	●	●	●	●
	Bearing	●	●	●	●	●	●
	Ball screw	—	—	—	—	—	—
	Ball spline	—	—	—	—	—	—

RV-4FR / RV-4FRL / RV-7FR / RV-7FRL

Joint axis		J1 axis	J2 axis	J3 axis	J4 axis	J5 axis	J6 axis
Consumable part	Grease	●	●	●	●	●	●
	Timing belt	●	—	●	●	●	●
Overhaulable part	Reduction gear	●	●	●	●	●	●
	Bearing	●	—	●	●	●	●
	Ball screw	—	—	—	—	—	—
	Ball spline	—	—	—	—	—	—

RV-13FR / RV-13FRL / RV-20FR / RV-7FRL

Joint axis		J1 axis	J2 axis	J3 axis	J4 axis	J5 axis	J6 axis
Consumable part	Grease	●	●	●	●	●	●
	Timing belt	—	—	—	●	●	●
Overhaulable part	Reduction gear	●	●	●	●	●	●
	Bearing	—	—	—	●	●	●
	Ball screw	—	—	—	—	—	—
	Ball spline	—	—	—	—	—	—

RV-8CRL

Joint axis		J1 axis	J2 axis	J3 axis	J4 axis	J5 axis	J6 axis
Consumable part	Grease	●	●	●	●	●	●
	Timing belt	—	—	—	●	●	—
Overhaulable part	Reduction gear	●	●	●	●	●	●
	Bearing	—	—	—	●	●	—
	Ball screw	—	—	—	—	—	—
	Ball spline	—	—	—	—	—	—

RH-3FRH / RH-6FRH / RH-12FRH / RH-20FRH / RH-3CRH / RH-6CRH

Joint axis		J1 axis	J2 axis	J3 axis	J4 axis
Consumable part	Grease	●	●	●	—
	Timing belt	—	—	●	●
Overhaulable part	Reduction gear	●	●	—	—
	Bearing	—	—	●*1	●
	Ball screw	—	—	●*2	—
	Ball spline	—	—	—	●*2

*1: The J3 axes of the RH-3FRH, RH-3CRH, and RH-6CRH do not use bearings (-).

*2: The RH-3FRH, RH-3CRH, and RH-6CRH use ball screw splines. However, this function assumes that the J3 axis uses a ball screw, and the J4 axis uses a ball spline.

RH-3FRHR

Joint axis		J1 axis	J2 axis	J3 axis	J4 axis
Consumable part	Grease	●	●	●	—
	Timing belt	●	●	●	●
Overhaulable part	Reduction gear	●	●	—	—
	Bearing	●	●	—	●
	Ball screw	—	—	●*3	—
	Ball spline	—	—	—	●*3

*3: The RH-3FRHR use ball screw splines. However, this function assumes that the J3 axis uses a ball screw, and the J4 axis uses a ball spline.

Functions reference

■ Axes monitored by the fault detection function

(●: Monitored, x: Not monitored)

RV-2FR / RV-2FRL

Joint axis	J1 axis	J2 axis	J3 axis	J4 axis	J5 axis	J6 axis
Reduction gear	●	●	●	●	●	●
Encoder	●	●	●	●	●	●
Battery	●					

RV-4FR / RV-4FRL / RV-7FR / RV-7FRL

Joint axis	J1 axis	J2 axis	J3 axis	J4 axis	J5 axis	J6 axis
Reduction gear	●	●	●	●	●	●
Encoder	●	●	●	●	●	●
Battery	●					

RV-13FR / RV-13FRL / RV-20FR / RV-7FRL

Joint axis	J1 axis	J2 axis	J3 axis	J4 axis	J5 axis	J6 axis
Reduction gear	x	x	x	●	●	●
Encoder	●	●	●	●	●	●
Battery	●					

RV-8CRL

Joint axis	J1 axis	J2 axis	J3 axis	J4 axis	J5 axis	J6 axis
Reduction gear	●	●	●	●	●	●
Encoder	●	●	●	●	●	●
Battery	●					

RH-3FRH / RH-6FRH / RH-12FRH / RH-20FRH / RH-3CRH / RH-6CRH

Joint axis	J1 axis	J2 axis	J3 axis	J4 axis
Reduction gear	●	●	x	x
Encoder	●	●	●	●
Battery	●			

RH-3FRHR

Joint axis	J1 axis	J2 axis	J3 axis	J4 axis
Reduction gear	●	●	x	x
Encoder	●	●	●	●
Battery	●			

Notes

Notes

Notes

Mitsubishi Electric Corporation Nagoya Works
is a factory certified for ISO 14001
(standards for environmental management
systems).



MITSUBISHI ELECTRIC CORPORATION

HEAD OFFICE: TOKYO BLDG., 2-7-3, MARUNOUCHI, CHIYODA-KU, TOKYO 100-8310, JAPAN